



IMAGENEX MODEL 864 PROGRAMMABLE DIGITAL ALTIMETER

APPLICATIONS:

- Measure altitude of structures & objects
- Measure range to other structures & objects
- Monitor sedimentation or scouring
- ROV, AUV, & UUV

FEATURES:

- Programmable
- Self contained
- Serial output
- Compact size

The Imagenex Model 864 is a completely self-contained altimeter with a digital input/output. This unit is compatible with the Model 881A switch data command and return data formats. This unit is mounted in a pressure proof housing with an underwater connector for use at depth. The 864 Altimeter measures the range to the bottom or other large objects. It requires only power and an RS-485 or RS-232 serial interface to an external device.



Model shown is 3000 m depth rated

HARDWARE SPECIFICATIONS:	
FREQUENCY	330 kHz
TRANSDUCER	Conical beam
TRANSDUCER BEAM WIDTH	10°
TRANSMIT PULSE LENGTH	100 microseconds
RANGE RESOLUTION	20 mm
MIN. DETECTABLE RANGE	100 mm
MAX. OPERATING DEPTH	1000 m (3000 m and 6000 m available)
MAX. CABLE LENGTH	1000 m on typical twisted shielded pair (RS-485)
INTERFACE	RS-485 serial interface @ 115.2 kbps (or optional RS-232), 881A style protocol
CONNECTOR	Four conductor, wet mateable (Subconn MCBH4M-AS)
POWER SUPPLY	22 – 32 VDC at 100 mA max.
DIMENSIONS	89 mm (3.5") diameter x 119 mm (4.7") length Overall length: 155 mm (6.1")
WEIGHT: In Air	1000 m unit: 1 kg (2.2 lbs)
In Water	1000 m unit: 0.4 kg (0.8 lbs)
MATERIALS (all depths)	6061-T6 Aluminum & PVC
FINISH	Anodized

SOFTWARE SPECIFICATIONS:	Win881A.exe v2.39
WINDOWS™ OPERATING SYSTEM	Windows™ XP, Vista, 7, 8, 10
RANGE SCALES	1 m, 2 m, 3 m, 4 m, 5 m, 10 m, 20 m, 30 m, 40 m, 50 m
FILE FORMAT	(filename).81a
RECOMMENDED MINIMUM COMPUTER REQUIREMENTS:	100 MHz Pentium 64 MB RAM 1 GB Hard Disk 800 x 600 x 256 colour graphics

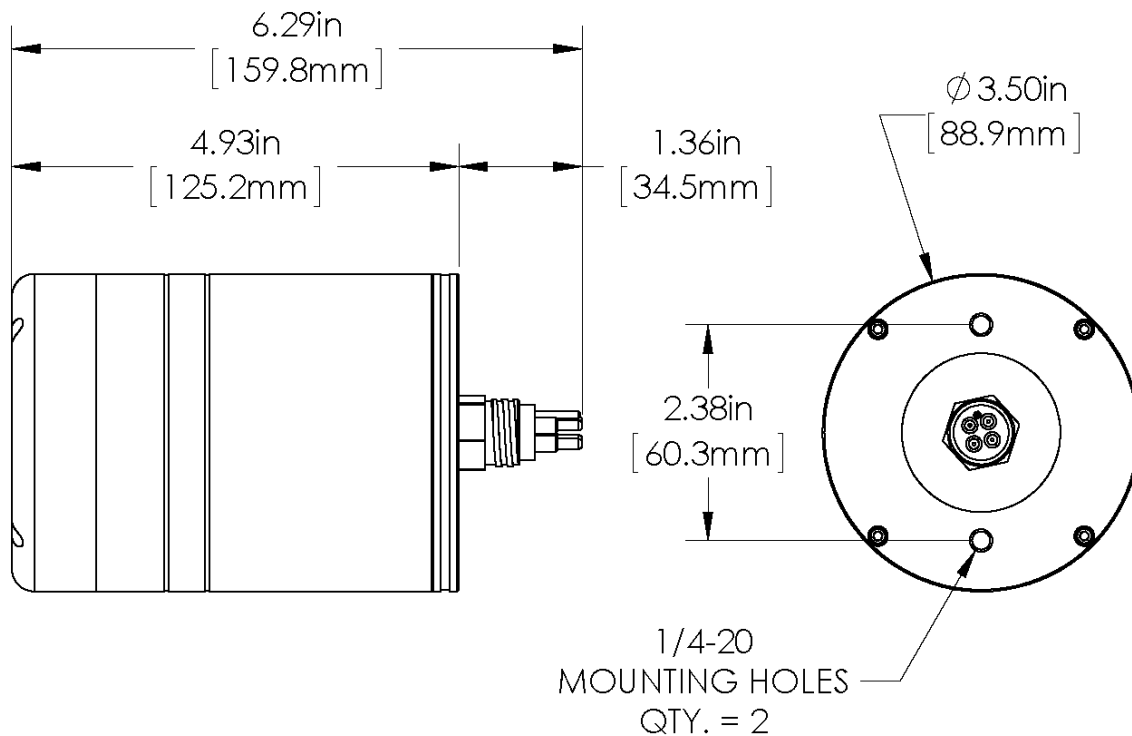

ORDERING INFORMATION:		
1000 m UNIT	Standard	864-000-200
3000 m UNIT	Standard	864-000-201
6000 m UNIT	Standard	864-000-202
RS-232	Option	-006

Product and company names listed are trademarks or trade names of their respective companies.